



**FAHRZEUG-
EINRICHTUNGEN**

**FITTINGS FOR
COMMERCIAL VEHICLES**



CITROËN BERLINGO



STOREVAN ORANGE PLANET - STOREVAN ORANGE PLANET

**STOREVAN ORANGE PLANET**

Nachhaltigkeit und ökologische Entwicklung sind Themen von großem, aktuellem Interesse, entstanden durch das steigende Bewusstsein, dass auf die Umweltbalance aufgrund der zyklischen Veränderungen und Erneuerungen geachtet werden muss.

STOREVAN ORANGE PLANET

Environmental sustainability and eco-compatible development are topics of great interest and relevance, arising from the growing awareness that it is important to pay attention to the environmental balance.

ZERTIFIZIERUNGEN - CERTIFICATIONS

ZERTIFIZIERTE PRODUKTION

- Nach ISO 9001:2015 zertifiziert.
- Erfolgreicher CRASH TEST durchgeführt nach ECE-R17 mit einer Aufprallgeschwindigkeit von 50 Km/h.
- GS-Zertifizierung für Inneneinrichtungen und Laderampen.
- GS-Zertifizierung für Dachträger und Leiterträger.

CERTIFIED PRODUCTION

- ISO 9001:2015 certified.
- Brilliantly passed the CRASH TEST carried out according to the most recent European regulations ECE-R17 with impact at 50 Km/h.
- GS certification for interior fittings and loading ramps.
- GS certification for roof and ladder racks.



StoreVan ist weltweit der einzige Hersteller von Nutzfahrzeugeinrichtungen, der mit dieser Technologie arbeitet.

StoreVan is the sole LCV's equipment manufacturer worldwide to make use of this technology.



GALVANNEALED STAHL

Galvannealed Blech ist eine Variante von feuerverzinktem Blech. Das Produkt unterliegt einem Feuerbeschichtungsprozess und wird bis ca. 550 °C erhitzt. Dies ermöglicht es dem Zink mit dem Stahlblech eine Legierung einzugehen. Das Ergebnis ist eine Beschichtung mit einer gleichförmigen, feinkörnigen Kristallstruktur an der Beschichtungsoberfläche und einer **sehr hohen Oberflächenqualität und Korrosionsbeständigkeit**.

Dieses Verfahren ist ideal für Automotive Anwendungen. StoreVan hat diese Technik nun auch im Bereich Nutzfahrzeugeinrichtungen implementiert.

DAS VERFAHREN DER KATHODISCHEN ACRYL-TAUCHLACKIERUNG

Die kathodische Acryl-Beschichtung ist eine Oberflächenbehandlung, die den einzelnen Teilen der Einrichtung eine **extrem hohe Korrosionsbeständigkeit** verleiht. Das Tauchverfahren gewährleistet eine **gleichmäßige Beschichtung** und einen lang anhaltenden Schutz egal gegen welche Stoffe. Das Acrylharz schützt den Lack bei direkter Belichtung durch die Witterung gegen Ausbleichen und gegen Veränderungen der Korrosionsbeständigkeit.

- Korrosionsbeständigkeit von über 500 Stunden (ASTM D1735 Luftfeuchtigkeit)
- Ausgezeichnete Härte mit einem Mindestrating von 2H



GALVANNEALED STEEL

Galvannealed sheet is a variant of hot-dip galvanized sheet. The product is subject to a hot-dip-galvanization process and subsequently heated to approximately 550°C, combining the zinc with the sheet surface to make an alloy with iron. The result is a uniform zinc coating with a fine-grained crystalline structure along with a **much higher surface quality and corrosion resistance**. This process is ideal for automotive applications. StoreVan introduced and implemented this technology in the commercial vehicles equipment field.

CATHODIC DIP PAINTING WITH ACRYLIC RESIN

Cataphoresis painting is a paint surface treatment able to give the equipment elements a **remarkable resistance to corrosion**; characterized by **uniform deposit** of an acrylic resin on the element surface, it ensures long lasting and high protection against chemical agents and other types of surface attacks. The acrylic resin allows a direct exposure to atmospheric agents without altering its technical features. This process ensures an increased protection against rust.

- Corrosion resistance of more than 500 hours (humidity ASTM D1735)
- Excellent hardness with a minimum rating of 2H







CITROËN BERLINGO

KASTENWAGEN - PANEL VAN

BODENPLATTE UND SEITENVERKLEIDUNGEN - FLOORING AND LININGS

- Bodenplatte und Seitenverkleidungen für Fahrzeug mit rechter Schiebetür und Seitenwänden aus Vollblech.
- Flooring and linings for right side door vehicle with metal sheet sidewalls.

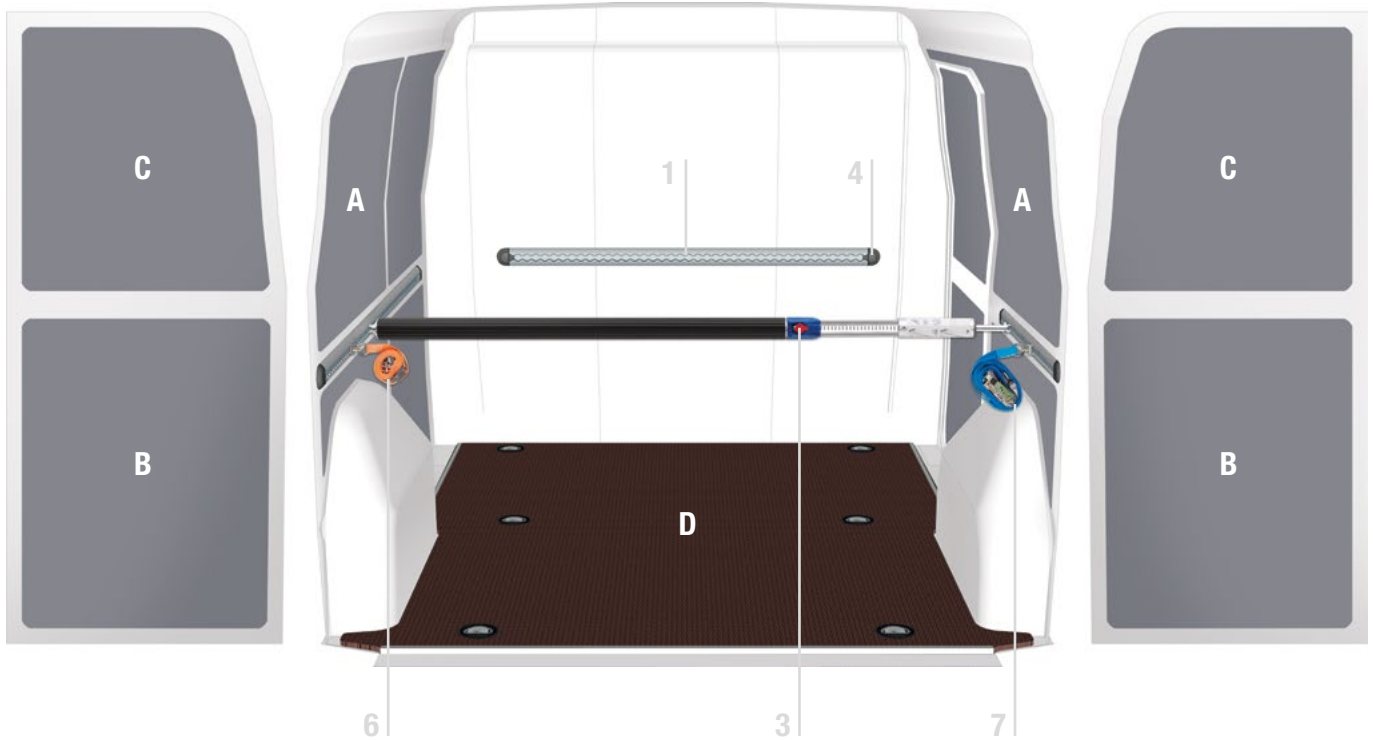

FAHRZEUG VEHICLE	BODENPLATTE 12 mm 12 mm FLOORING	SEITENVERKLEIDUNG LINING	SEITENVERKLEIDUNG LINING
	D	A+B	C
	ART. NR. / ITEM NO.	ART. NR. / ITEM NO.	ART. NR. / ITEM NO.
Fahrzeugtyp - Model L1	PIL 011 17,65 kg	PAN 020 3,58 kg	PAR 007 1,02 kg
Fahrzeugtyp - Model L2	PIL 012 20,20 kg	PAN 021 4,92 kg	PAR 007 1,02 kg

BODENPLATTE UND SEITENVERKLEIDUNGEN - FLOORING AND LININGS

PAN

- Seitenverkleidung aus Polypropylen für:
 - linke Seitenwand
 - rechte Seitenwand und Schiebetür
- Polypropylene linings for:
 - LH sidewall
 - RH sidewall and sliding door

PAR

- Seitenverkleidung aus Polypropylen für:
 - oberen Teil der Heckflügeltüren
- Polypropylene linings for:
 - upper part of rear hinged doors

PIL

- Bodenplatte aus Multiplex mit Phenolbeschichtung, Stärke 12 mm, für das Originalverankerungssystem des Fahrzeugs vorgebohrt.
- 12 mm thick wooden flooring with phenolic coating set for the vehicles original anchoring system

LADUNGSSICHERUNG - LOAD SECURING

BESCHREIBUNG - DESCRIPTION

- Horizontale Aluschiene.
- Horizontal aluminium bar.

ALUSCHIENE - BAR	1	LÄNGE - LENGTH
ART. NR. / ITEM NO. F 22 FC V18029 05 00		500 mm
ART. NR. / ITEM NO. F 22 FC V18029 10 00		1000 mm
ART. NR. / ITEM NO. F 22 FC V18029 15 00		1500 mm
ART. NR. / ITEM NO. F 22 FC V18029 20 00		2000 mm
ART. NR. / ITEM NO. F 22 FC V18029 25 00		2500 mm

BESCHREIBUNG - DESCRIPTION

- Horizontale Aluschiene für Seitenwände.
- Horizontal aluminium bar for side panels.

ALUSCHIENE - BAR	2	LÄNGE - LENGTH
ART. NR. / ITEM NO. F 22 FC V18025 05 00		500 mm
ART. NR. / ITEM NO. F 22 FC V18025 10 00		1000 mm
ART. NR. / ITEM NO. F 22 FC V18025 15 00		1500 mm

BESCHREIBUNG - DESCRIPTION

- Teleskopische Spannstanze.
- Telescopic load restraining bar.

STANGE - BAR	3	HÖHE - HEIGHT
ART. NR. / ITEM NO. F 22 FC V22149 00 00		650-900 mm
ART. NR. / ITEM NO. F 22 FC V22131 00 00		1250-1750 mm
ART. NR. / ITEM NO. F 22 FC V22017 00 00		1550-2050 mm

BESCHREIBUNG - DESCRIPTION

- Endstück aus Kunststoff für Aluschiene Serie V18029.
- Plastic end cap for bar series V18029.

ENDSTÜCK FÜR ALUSCHIENE - PLASTIC END CAP FOR BAR	4
ART. NR. / ITEM NO. F 22 FC V22106 00 00	

BESCHREIBUNG - DESCRIPTION

- Zurring.
- Ring stud fitting.

ZURRRING - RING STUD FITTING	5
ART. NR. / ITEM NO. F 22 FC V22090 00 00	

BESCHREIBUNG - DESCRIPTION

- Zurring mit Hebelspannschloss 2500+500.
- Load restraining belt with clamp 2500+500.

ZURRGURT - BELT	6
ART. NR. / ITEM NO. F 22 FC V22136 00 00	

BESCHREIBUNG - DESCRIPTION

- Zurring mit Ratschenschloss 2500+500.
- Load restraining belt with ratchet 2500+500.

ZURRGURT - BELT	7
ART. NR. / ITEM NO. F 22 FC V22124 00 00	

Für weitere Informationen fordern Sie bitte unseren „Ladungssicherung“ - Katalog an

For more information, ask for our “Load Securing” catalogue





FAHRZEUGEINRICHTUNGSBEISPIELE - FITTINGS EXAMPLES

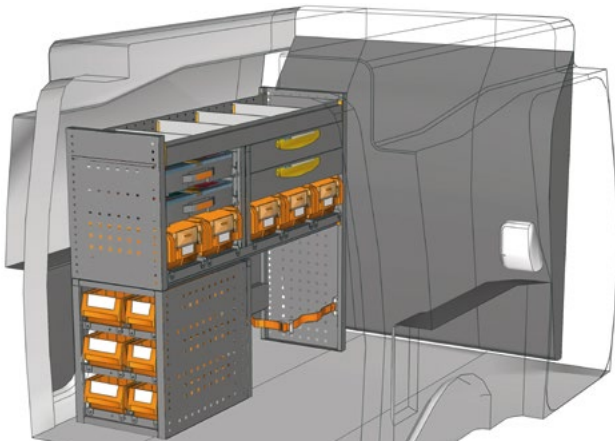

BEISPIEL - EXAMPLE

PA 1210 05*

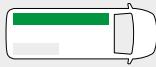

B=1225 T=365 H=1000 mm - W=1225 D=365 H=1000 mm

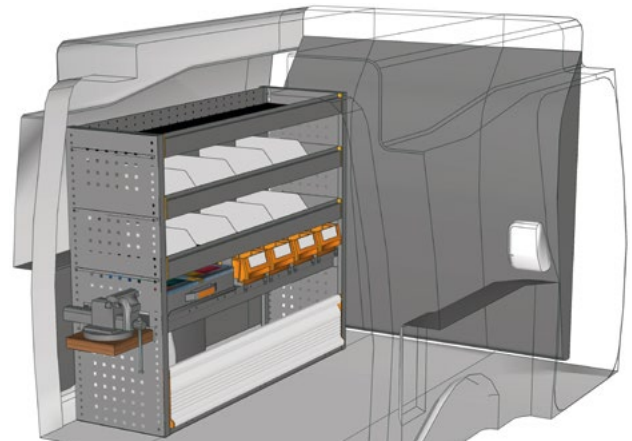

BEISPIEL - EXAMPLE

PA 1210 06*

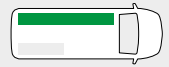

B=1225 T=365 H=1000 mm - W=1225 D=365 H=1000 mm

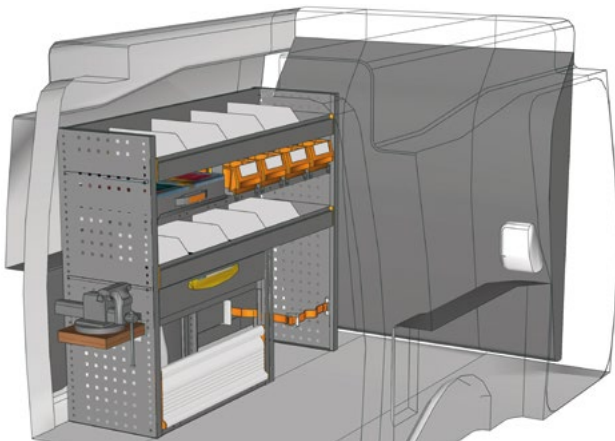

BEISPIEL - EXAMPLE

PA 1210 07*

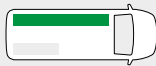

B=1225 T=365 H=1000 mm - W=1225 D=365 H=1000 mm

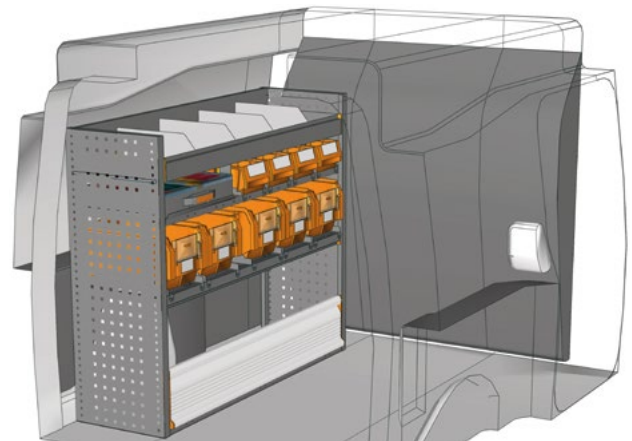

BEISPIEL - EXAMPLE

PA 1210 08*

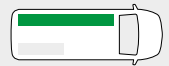

B=1225 T=365 H=1000 mm - W=1225 D=365 H=1000 mm

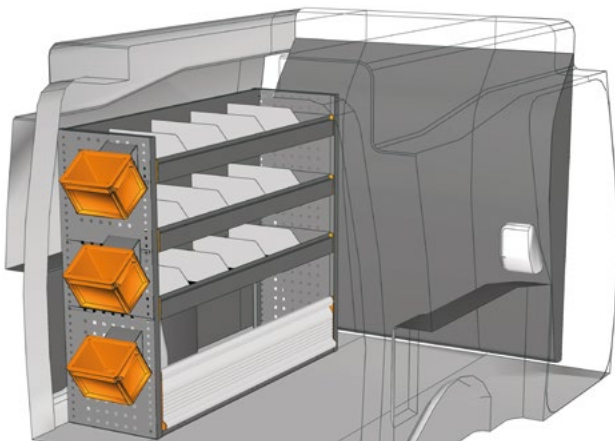

BEISPIEL - EXAMPLE

PA 1210 09*

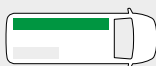

B=1225 T=365 H=1000 mm - W=1225 D=365 H=1000 mm

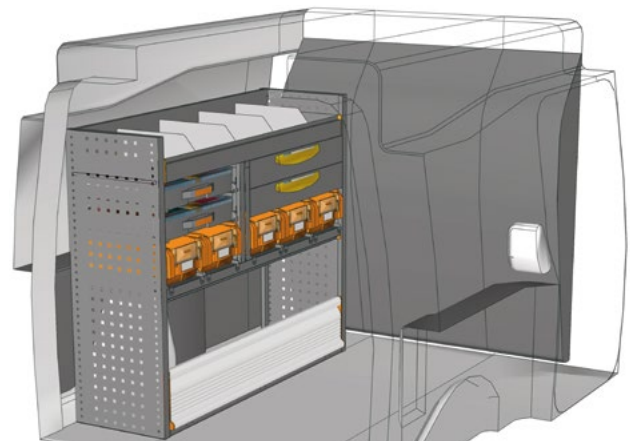

BEISPIEL - EXAMPLE

PA 1210 10*

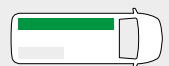

B=1225 T=365 H=1000 mm - W=1225 D=365 H=1000 mm



FAHRZEUGEINRICHTUNGSBEISPIELE - FITTINGS EXAMPLES

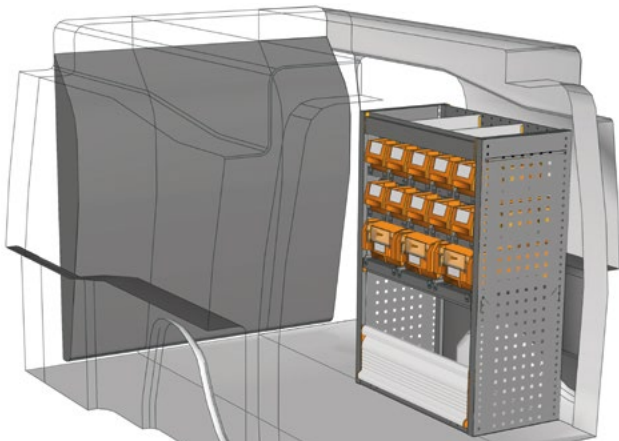

BEISPIEL - EXAMPLE

PA 0710 05*

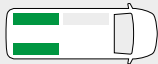

B=717 T=365 H=1000 mm - W=717 D=365 H=1000 mm

**Haben Sie Ihre Einrichtung nicht gefunden?
Verlassen Sie sich auf die Profis für
Fahrzeugeinrichtungen.**

Auf der Rückseite dieses Katalogs
finden Sie die nächstgelegene
StoreVan Niederlassung.
Besuchen Sie unsere Web-Seite.



**Didn't find the equipment
you're looking for?
Leave it to our experts.**

See the back of this catalogue
and contact the nearest
StoreVan point or visit our website.

*** Einschließlich Befestigungskit - Fixing kit included**

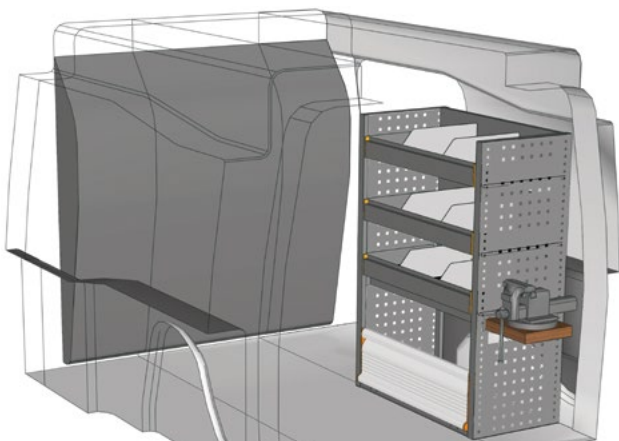

BEISPIEL - EXAMPLE

PA 0710 06*

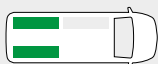

B=717 T=365 H=1000 mm - W=717 D=365 H=1000 mm

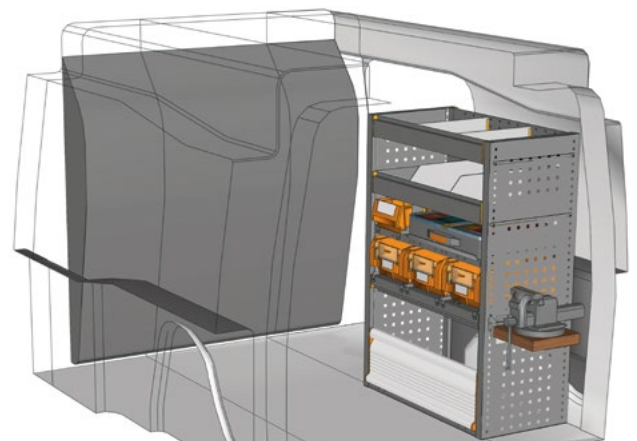

BEISPIEL - EXAMPLE

PA 0710 07*

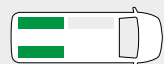

B=717 T=365 H=1000 mm - W=717 D=365 H=1000 mm

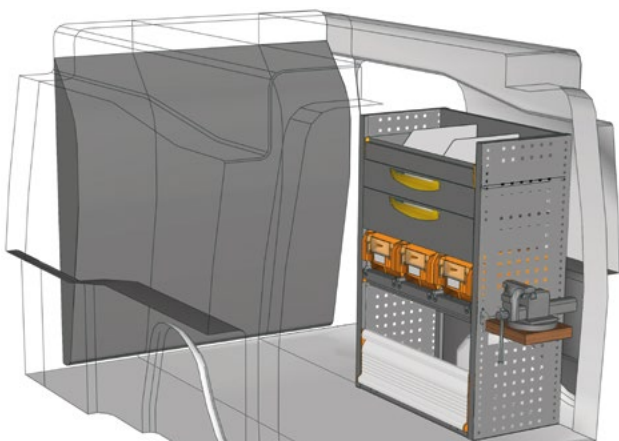

BEISPIEL - EXAMPLE

PA 0710 08*

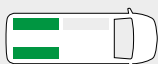

B=717 T=365 H=1000 mm - W=717 D=365 H=1000 mm

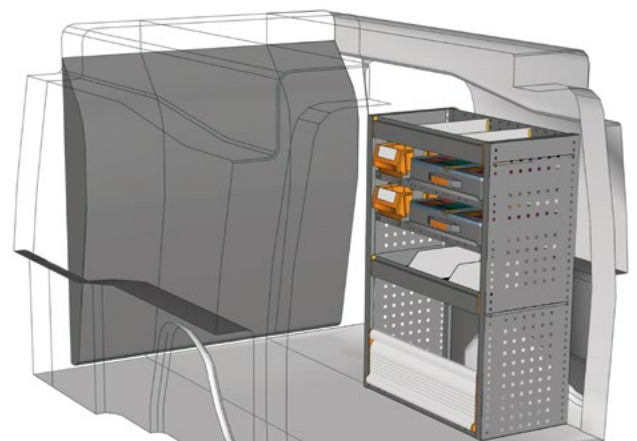

BEISPIEL - EXAMPLE

PA 0710 09*

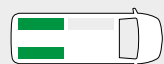

B=717 T=365 H=1000 mm - W=717 D=365 H=1000 mm



FAHRZEUGEINRICHTUNGSBEISPIELE - FITTINGS EXAMPLES

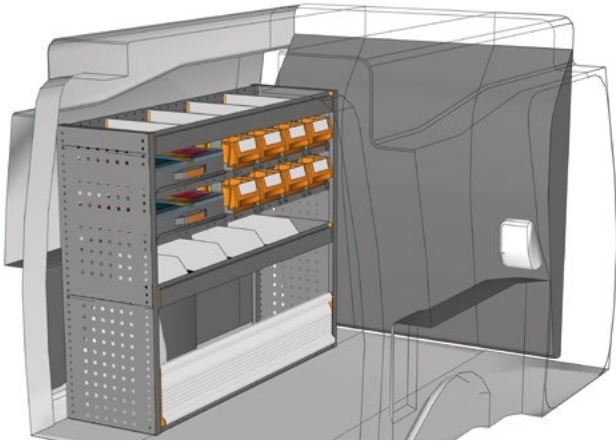

BEISPIEL - EXAMPLE

PA 1210 11*



B=1225 T=365 H=1000 mm - W=1225 D=365 H=1000 mm

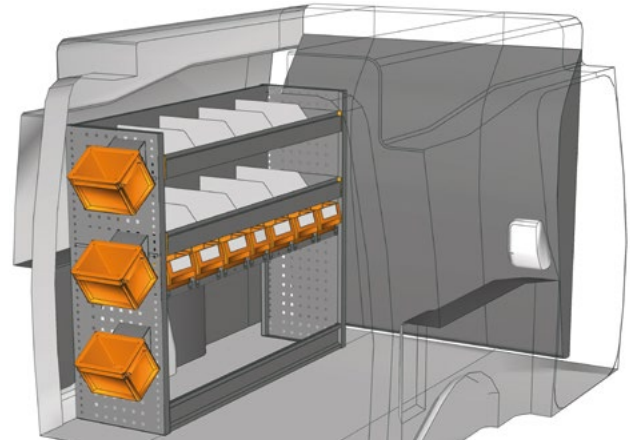

BEISPIEL - EXAMPLE

PA 1210 12*



B=1225 T=365 H=1000 mm - W=1225 D=365 H=1000 mm

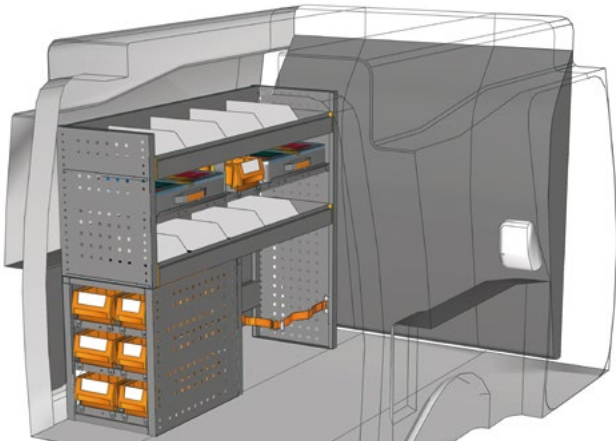

BEISPIEL - EXAMPLE

PA 1210 13*



B=1225 T=365 H=1000 mm - W=1225 D=365 H=1000 mm

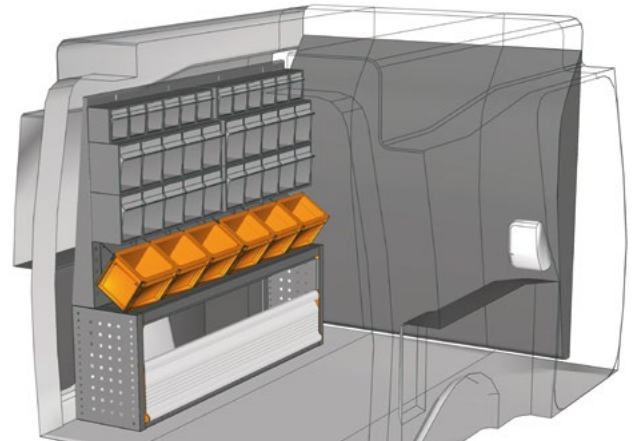

BEISPIEL - EXAMPLE

PA 1211 04*



B=1225 T=265 H=1100 mm - W=1225 D=265 H=1100 mm

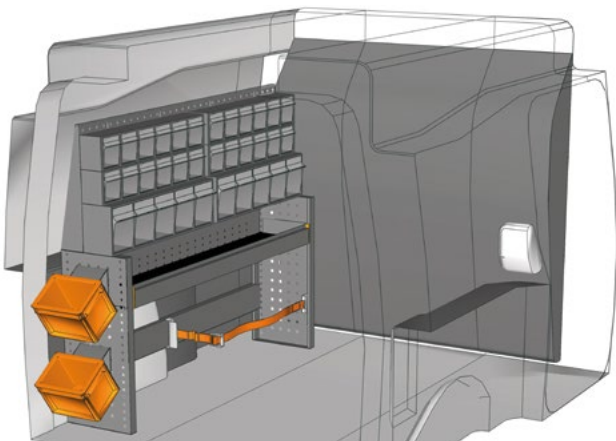

BEISPIEL - EXAMPLE

PA 1211 05*

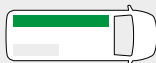

B=1225 T=265 H=1020 mm - W=1225 D=265 H=1020 mm

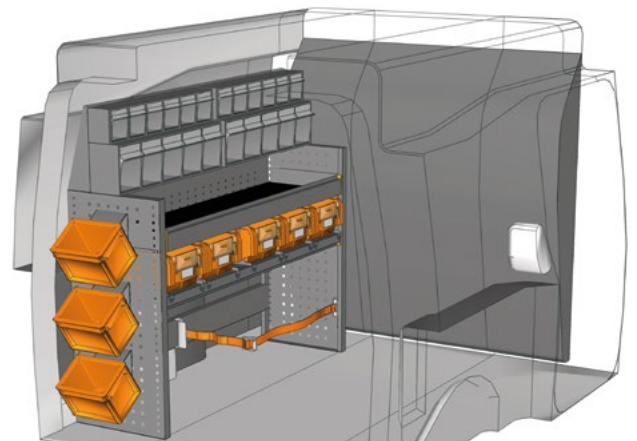

BEISPIEL - EXAMPLE

PA 1211 06*

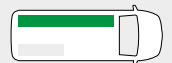

B=1225 T=365 H=1080 mm - W=1225 D=365 H=1080 mm



FAHRZEUGEINRICHTUNGSBEISPIELE - FITTINGS EXAMPLES

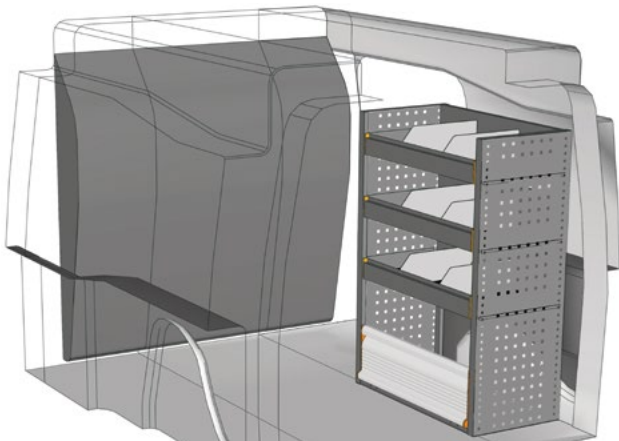

BEISPIEL - EXAMPLE

PA 0710 10*

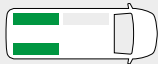

B=717 T=365 H=1000 mm - W=717 D=365 H=1000 mm

**Haben Sie Ihre Einrichtung nicht gefunden?
Verlassen Sie sich auf die Profis für
Fahrzeugeinrichtungen.**

Auf der Rückseite dieses Katalogs
finden Sie die nächstgelegene
StoreVan Niederlassung.
Besuchen Sie unsere Web-Seite.



**Didn't find the equipment
you're looking for?
Leave it to our experts.**

See the back of this catalogue
and contact the nearest
StoreVan point or visit our website.

*** Einschließlich Befestigungskit - Fixing kit included**

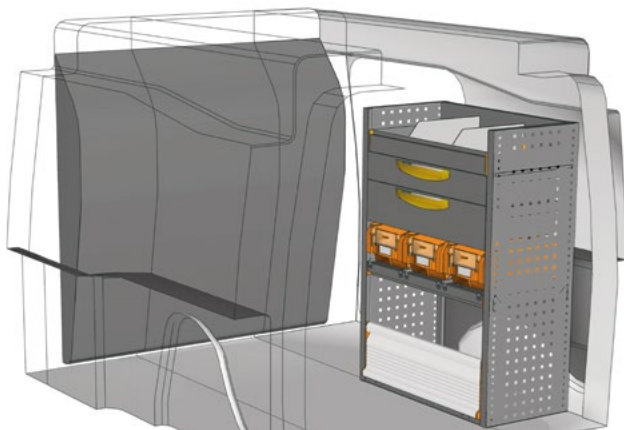

BEISPIEL - EXAMPLE

PA 0710 11*



B=717 T=365 H=1000 mm - W=717 D=365 H=1000 mm

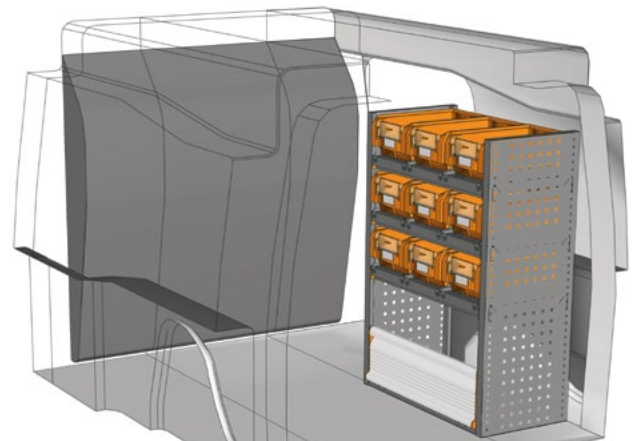

BEISPIEL - EXAMPLE

PA 0710 12*



B=717 T=365 H=1000 mm - W=717 D=365 H=1000 mm

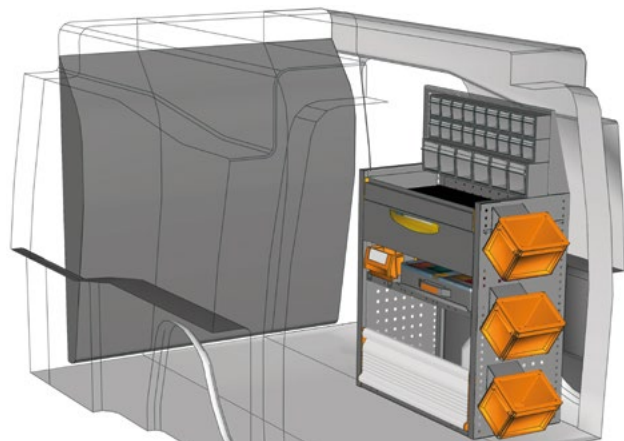

BEISPIEL - EXAMPLE

PA 0711 03*

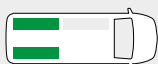

B=717 T=365 H=1080 mm - W=717 D=365 H=1080 mm

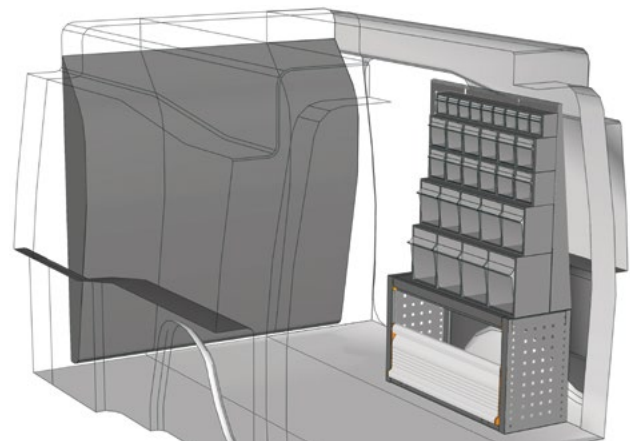

BEISPIEL - EXAMPLE

PA 0711 04*

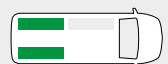

B=717 T=265 H=1100 mm - W=717 D=265 H=1100 mm

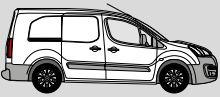

FAHRZEUGEINRICHTUNGSBEISPIELE - FITTINGS EXAMPLES

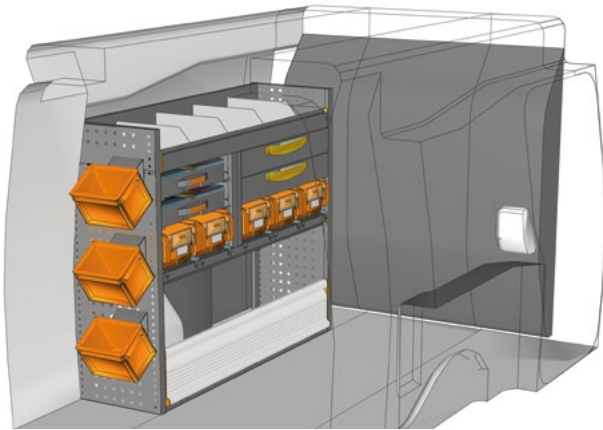

BEISPIEL - EXAMPLE

PA 1210 01*

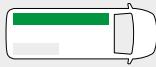

B=1225 T=365 H=1000 mm - W=1225 D=365 H=1000 mm

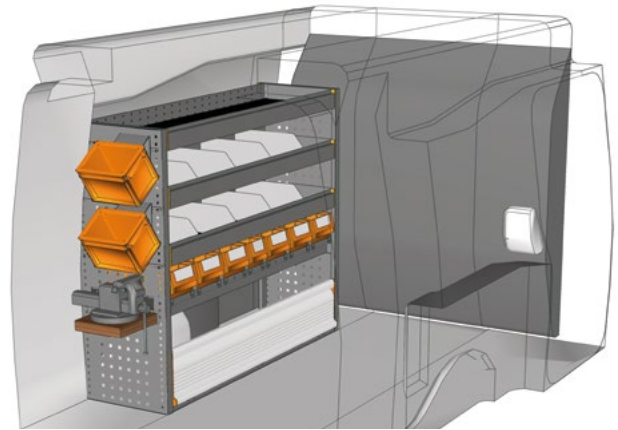

BEISPIEL - EXAMPLE

PA 1210 02*

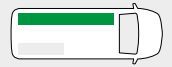

B=1225 T=365 H=1000 mm - W=1225 D=365 H=1000 mm

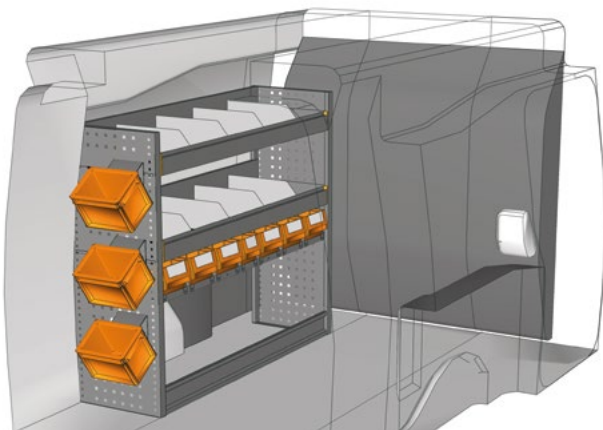

BEISPIEL - EXAMPLE

PA 1210 03*

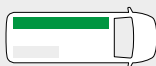

B=1225 T=365 H=1000 mm - W=1225 D=365 H=1000 mm

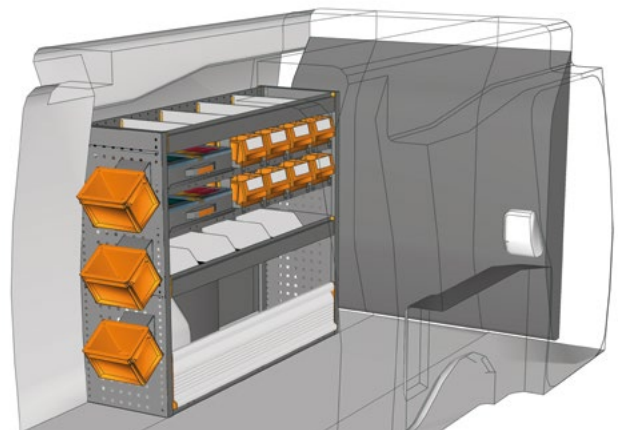

BEISPIEL - EXAMPLE

PA 1210 04*

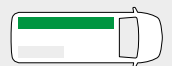

B=1225 T=365 H=1000 mm - W=1225 D=365 H=1000 mm

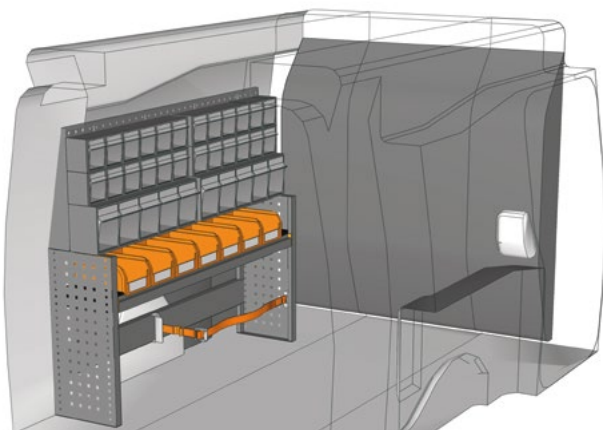

BEISPIEL - EXAMPLE

PA 1211 02*

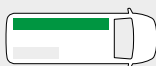

B=1225 T=265 H=1020 mm - W=1225 D=265 H=1020 mm

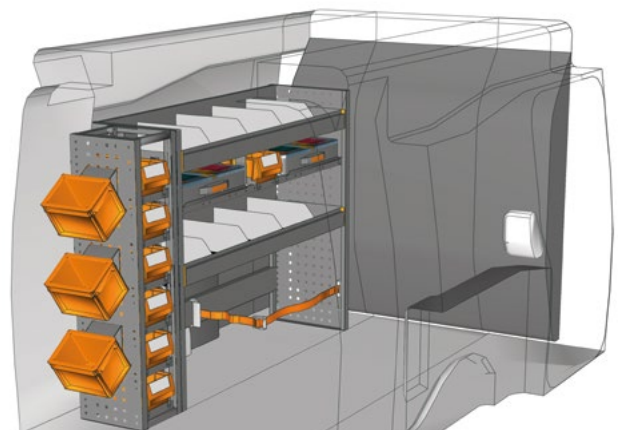

BEISPIEL - EXAMPLE

PA 1410 01*

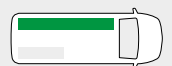

B=1460 T=365 H=1000 mm - W=1460 D=365 H=1000 mm



FAHRZEUGEINRICHTUNGSBEISPIELE - FITTINGS EXAMPLES

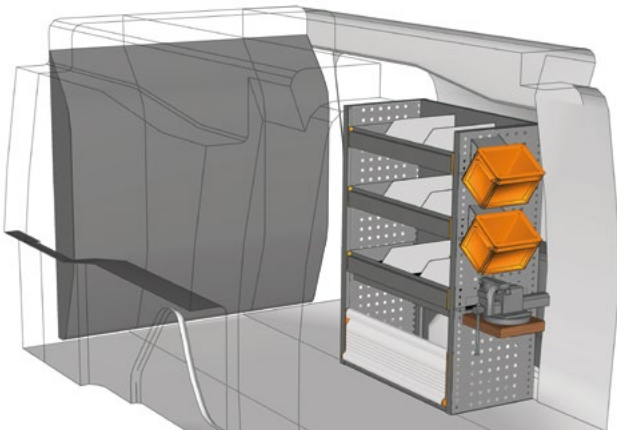

BEISPIEL - EXAMPLE

PA 0710 01*

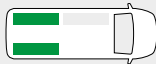

B=717 T=365 H=1000 mm - W=717 D=365 H=1000 mm

**Haben Sie Ihre Einrichtung nicht gefunden?
Verlassen Sie sich auf die Profis für
Fahrzeugeinrichtungen.**

Auf der Rückseite dieses Katalogs
finden Sie die nächstgelegene
StoreVan Niederlassung.
Besuchen Sie unsere Web-Seite.



**Didn't find the equipment
you're looking for?
Leave it to our experts.**

See the back of this catalogue
and contact the nearest
StoreVan point or visit our website.

*** Einschließlich Befestigungskit - Fixing kit included**

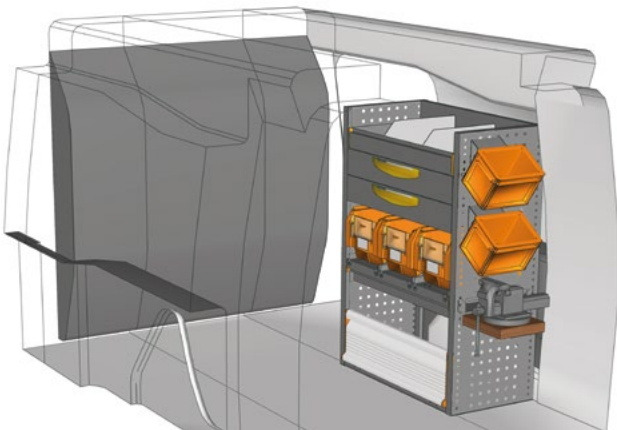

BEISPIEL - EXAMPLE

PA 0710 02*

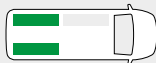

B=717 T=365 H=1000 mm - W=717 D=365 H=1000 mm

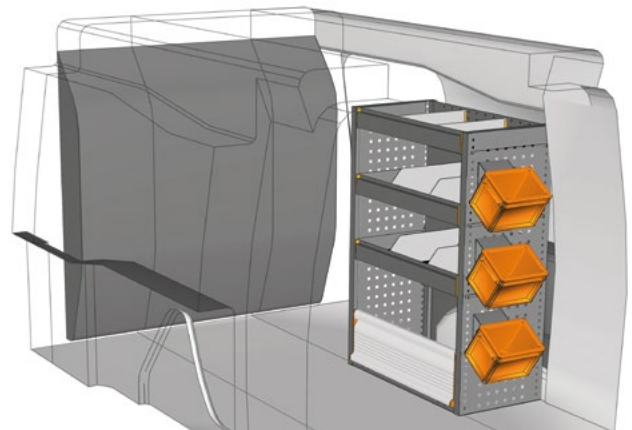

BEISPIEL - EXAMPLE

PA 0710 04*

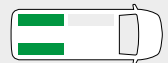

B=717 T=365 H=1000 mm - W=717 D=365 H=1000 mm

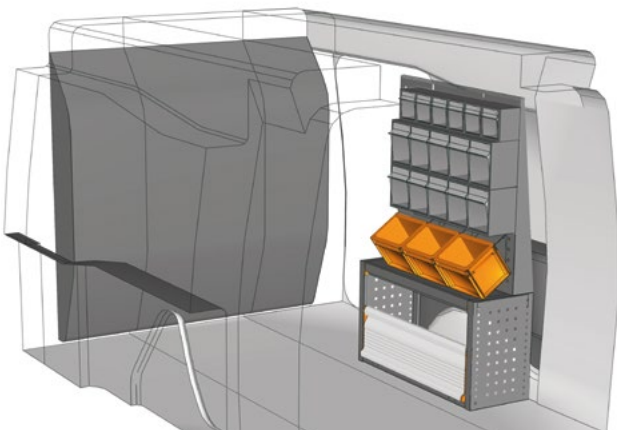

BEISPIEL - EXAMPLE

PA 0711 01*

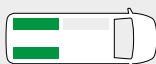

B=717 T=365 H=1100 mm - W=717 D=365 H=1100 mm

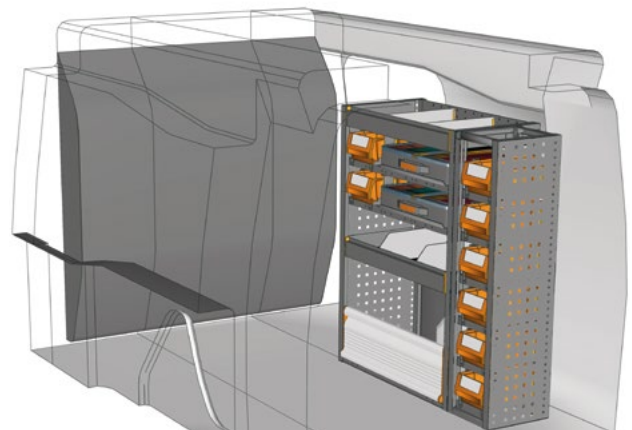

BEISPIEL - EXAMPLE

PA 0910 01*

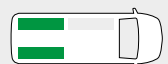

B=952 T=365 H=1000 mm - W=952 D=365 H=1000 mm



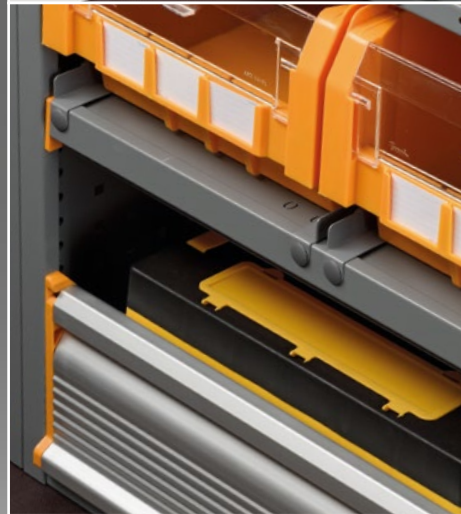



CITROËN BERLINGO

KASTENWAGEN - PANEL VAN



DACHTRÄGER UND LEITERTRÄGER - ROOF AND LADDER RACK



FAHRZEUG VEHICLE	DACHTRÄGER ROOF RACK	ABMESSUNGEN DIMENSIONS	GEWICHT WEIGHT	TRAGKRAFT LOAD CAPACITY
	ART. NR. / ITEM NO.			
Fahrzeugtyp - Model L1	POT 011	2000x1400 mm	22,00 kg	77,00 kg
Fahrzeugtyp - Model L2	POT 012	2500x1400 mm	23,92 kg	75,00 kg

- Nur für Fahrzeug mit Heckflügeltüren.
- Only for vehicle with rear leaf doors.

POT

- Dachträger bestehend aus:
 - Alu-Querschienen inkl. Befestigungen und Gummiprofilen
 - Seitenwänden aus Aluminium
 - Laderolle aus Aluminium
 - Schraubmaterial aus Edelstahl
- Roof rack complete of:
 - aluminium crossbars with fixing parts and rubber profile
 - aluminium side rails
 - aluminium loading roller
 - fixing screws in stainless steel

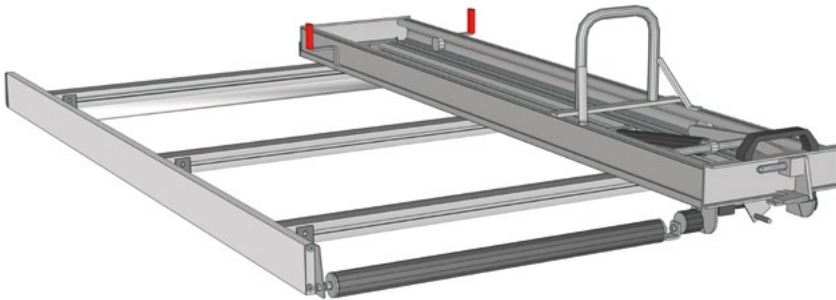

FAHRZEUG VEHICLE	LEITERTRÄGER LADDER RACK	ABMESSUNGEN DIMENSIONS	GEWICHT WEIGHT	TRAGKRAFT LOAD CAPACITY
	ART. NR. / ITEM NO.			
Fahrzeugtyp - Model L1	POS 013	2110x1380 mm	43,55 kg	56,00 kg
Fahrzeugtyp - Model L2	POS 014	2650x1380 mm	48,74 kg	51,00 kg

- Nur für Fahrzeug mit Heckflügeltüren. Der Leiterträger kann links oder rechts montiert werden.
- Only for vehicle with rear leaf doors. The ladder rack rail can be mounted on the right or left side.

POS

- Leiterträger bestehend aus:
 - Alu-Querschienen inkl. Befestigungen und Gummiprofilen
 - Seitenwand aus Aluminium
 - Laderolle aus Aluminium
 - Leiterschiene aus Aluminium und Edelstahl
 - Schraubmaterial aus Edelstahl
- Ladder rack complete of:
 - aluminium crossbars with fixing parts and rubber profile
 - aluminium side rail
 - aluminium loading roller
 - ladder rack rail made of aluminium and stainless steel
 - fixing screws in stainless steel



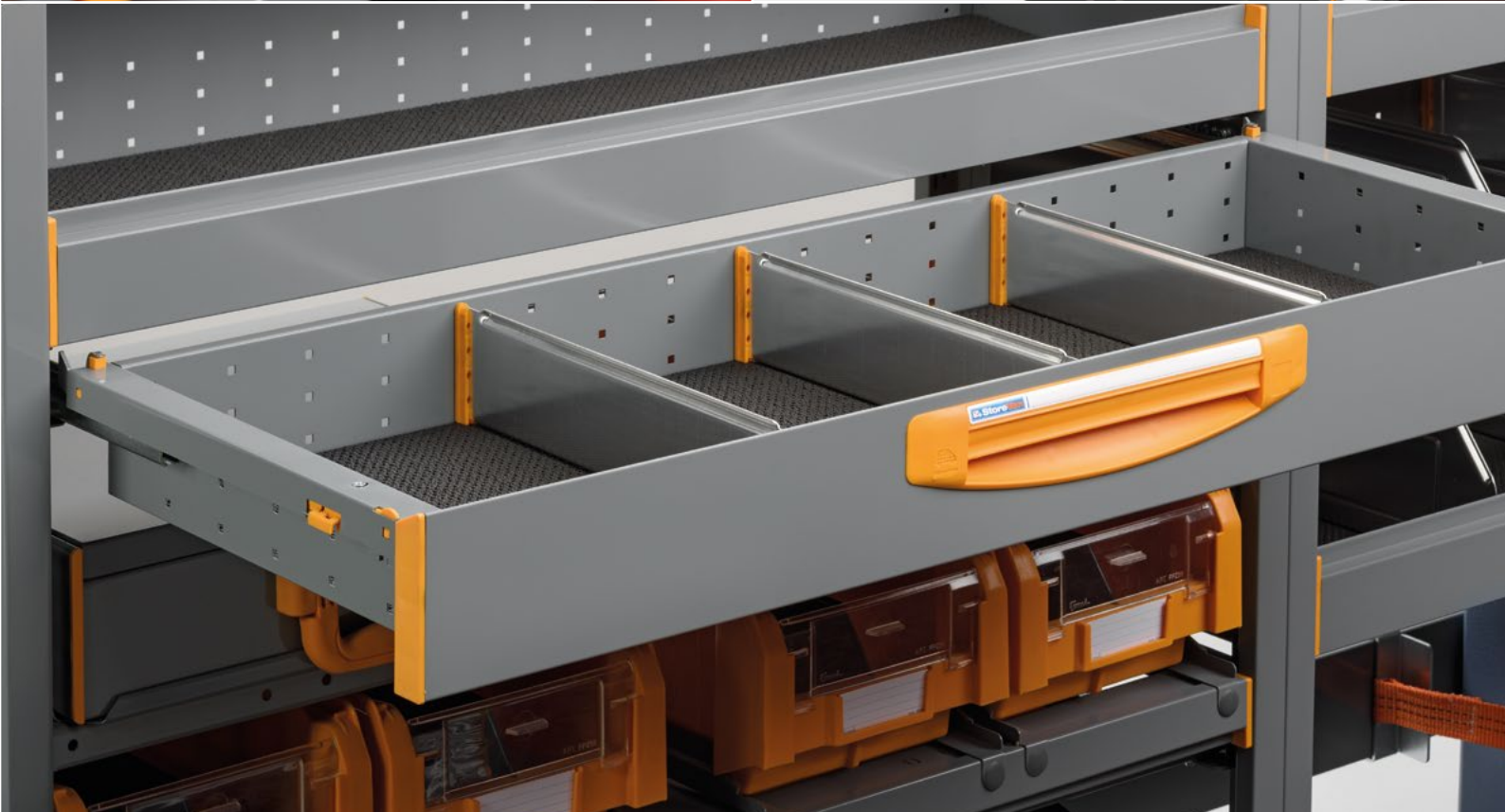
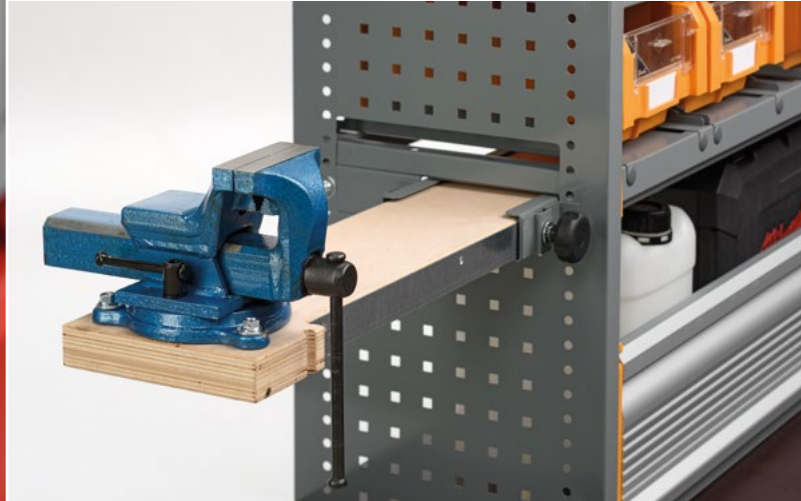

ZUBEHÖR - ACCESSORIES



ART. NR. / ITEM NO. ACS 005

- Papierrollen-Kit Ø 140 mm
- Paper roll holder Ø 140 mm



ART. NR. / ITEM NO. ACS 012

- Papierrollen-Kit Ø 240 mm
- Paper roll holder Ø 240 mm



ART. NR. / ITEM NO. ACS 013

- Silikonträgersatz
- Silicone holder kit



ART. NR. / ITEM NO. ACS 014

- Schlauchhalter
- Cable holder



ART. NR. / ITEM NO. ACS 004

- Erste-Hilfe-Kasten
- First aid kit



ART. NR. / ITEM NO. ACS 006

- Plantasche für DIN A4 Formate
- DIN A4 pocket document holder



ART. NR. / ITEM NO. ACS 007

- Spraydosenhalter
- Spray can holder



ART. NR. / ITEM NO. ACS 015

- Halterung mit 1 Behälter Größe 1PL
- Holder with 1 container measure 1 PL



ART. NR. / ITEM NO. ACS 016

- Halterung mit 3 Behältern Größe 1PL
- Holder with 3 containers measure 1 PL



ART. NR. / ITEM NO. ACS 017

- Halterung mit Behälter Größe 2115A
- Holder with box measure 2115A



ART. NR. / ITEM NO. ACS 001

- Handwasch-Kit
- Hand wash kit



ART. NR. / ITEM NO. ACS 002

- Kanisterhalter mit Kanister Inh. 20 Lt.
- Jerrycan holder with 20 litres iron jerrycan

ZUBEHÖR - ACCESSORIES

ART. NR. / ITEM NO. ACS 003
A

- Halterung mit Gurt für Flaschen und Feuerlöscher
- Holder with belt for gas cylinders and extinguishers

ART. NR. / ITEM NO. ACS 018
B

- Feuerlöscher 4 kg
- Fire extinguisher 4 kg

ART. NR. / ITEM NO. ACS 019

- All Safe Stange L=365 mm und Zurrurt mit Ratschenschloss
- All Safe bar L= 365 mm and ratchet belt

ART. NR. / ITEM NO. ACS 020
C

- All Safe Stange L=445 mm und Zurrurt mit Ratschenschloss
- All Safe bar L= 445 mm and ratchet belt

ART. NR. / ITEM NO. ACS 021

- All Safe Stange L=365 mm und Zurrurt mit Hebelspannschloss
- All Safe bar L= 365 mm and clamp belt

ART. NR. / ITEM NO. ACS 022
D

- All Safe Stange L=445 mm und Zurrurt mit Hebelspannschloss
- All Safe bar L= 445 mm and clamp belt

 Beispiel mit 2 **ART. NR. ACS 003**
 Example with 2 **ITEMS NO. ACS 003**

 Beispiel mit 2 **ART. NR. ACS 019**
 Example with 2 **ITEMS NO. ACS 019**

 Beispiel mit 2 **ART. NR. ACS 021**
 Example with 2 **ITEMS NO. ACS 021**

ART. NR. / ITEM NO. ACS 023

- Satz 10 Magnete Ø 20 mm
- Set of 10 magnets Ø 20 mm

ART. NR. / ITEM NO. ACS 024

- Satz 10 Magnete Ø 25 mm
- Set of 10 magnets Ø 25 mm

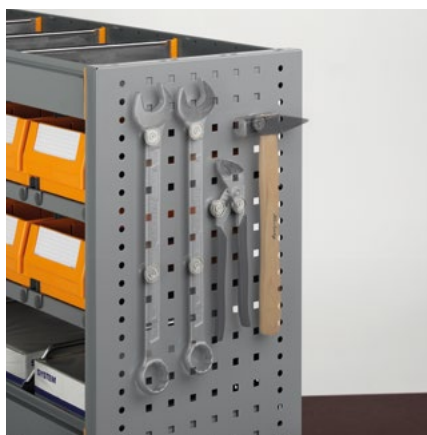
ART. NR. / ITEM NO. ACS 025

- LED-Lampe L=600 mm IP20 12V
- LED lamp L=600 mm IP20 12V

LIEFERBEDINGUNGEN

- Bodenplatten und Seitenverkleidungen werden in mehreren Teilen geliefert.
- Dachträger und Leiterträger werden **lose** geliefert.
- Module werden **vormontiert** komplett mit Fahrzeugbefestigungsmaterial geliefert.
- Produkte sollen vorzugsweise von **Vertragshändlern** installiert werden.
- Produkte werden **verpackt** geliefert.
- **3 Jahre Garantie** auf unsere Komponenten.
- Die Tragkräfte beziehen sich auf **gleichmäßig verteilte Last**.

SUPPLY CONDITIONS

- Flooring and linings supplied in several pieces.
- Roof and ladder racks supplied **flat-packed**.
- Modules are supplied **preassembled** complete of fixing material to the vehicle.
- For products installation, please get in touch with our **approved installer's network**.
- Products provided **with packaging**.
- Our products are covered by a **3-years warranty**.
- Load capacities refer to **uniformly distributed loads**.

WWW.STOREVAN.COM



FAMI S.r.l.

Via Stazione Rossano, 13 | 36027 Rosà (VI) | ITALY
phone +39 0424 585455 | fax +39 0424 585482
www.famisp.com | info@famisp.com
www.storevan.com | info@storevan.com